

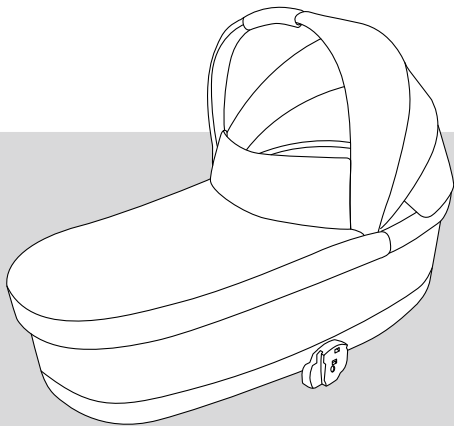

COT S LUX





EN WARNING
DE WARNUNG
ES ADVERTENCIA
FR AVERTISSEMENT
PT AVISOS
IT AVVERTENZA
NL WAARSCHUWING
PL OSTRZEŻENIE
CS UPOZORNĚNÍ
SK UPOZORNENIE
SL OPOZORILO
HR UPOZORENJE
HU FIGYELMEZTETÉS
SE VARNING
NO ADVARSEL
FI VAROITUS
DA ADVARSEL
ET HOIATUS
LV BRĪDINĀJUMS
LT PERSPĖJIMAS
RU ВНИМАНИЕ
UK УВАГА
TR UYARI
EL ΠΡΟΕΙΔΟΠΟΙΗΣΗ
RO AVERTISMENTE
IS VIÐVÖRUN
MT TWISSIJA

AR
FA
YUE 警告
CMN 警告
JA 警告
KO 경고
BG ПРЕДУПРЕЖДЕНИЕ
SR UPOZORENJE
MS AMARAN
HI चेतावनी
TH คำเตือน
SQ PARALAJMËRIM
BS UPOZORENJE
ME UPOZORENJE
MK ПРЕДУПРЕДУВАЊЕ
HY շօղախոսություն
VI CẢNH BÁO

تحذير
اخطار



EN Tutorial video
DE Videoanleitung
ES Tutorial en vídeo
FR Vidéo de démonstration
PT Video tutorial
IT Video tutorial
NL Instructievideo
PL Film instruktażowy
CS Výukové video
SK Výukové video
SL Video z navodili
HR Video s uputama
HU Bemutatóvideó
SE Videosjälvstudiekurs
NO Opplæringsvideo
FI Opetusvideo
DA Vejledende video
ET Õppevideo
LV Arpmācību video
LT Mokomasis vaizdo įrašas
RU Обучающее видео
UK Навчальне відео
TR Öğretici video
EL Εκπαιδευτικό βίντεο
RO Video tutorial
IS Kennslumyndband
MT Tutorial fuq vidjow

AR
FA
YUE 教程視頻
CMN 教程视频
JA チュートリアルビデオ
KO 튜토리얼 동영상
BG Учебно видео
SR Video sa uputstvima
MS Video tutorial
HI क्यूटोरियल वीडियो
TH วีดีโอแนะนำ
SQ Video udhëzuese
BS Video sa uputstvima
ME Video sa uputstvima
MK Видеоупатство
HY Παιδαγωγικά βίντεο
VI Video hướng dẫn

فیدویو تعلیمی
ویدئوی آموزشی

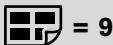

EN Maximum weights
DE Maximalgewichte
ES Pesos máximos
FR Poids maximum
PT Pesos máximos
IT Peso massimo
NL Maximumgewicht
PL Dopuszczalna waga
CS Maximální hmotnosti
SK Maximálne hmotnosti
SL Največje teže
HR Maksimalne težine
HU Maximális súlyok
SE Max.vikter
NO Maksimumsvektor
FI Enimmäispainot
DA Maksimumvægt
ET Maksimaalne kaal
LV Maksimālais svars
LT Didžiausi svoriai
RU Максимальная масса
UK Максимальна вага
TR Maksimum ağırlıklar

EL Μέγιστο βάρος
RO Greutăți maxime
IS Hámarksþyngd
MT Piżijiet massimi
AR الأوزان القصوى
FA حداکثر وزن
YUE 最大重量
CMN 最大重量
JA 最大重量
KO 최대 하중
BG Максимални тегла
SR Maksimalne težine
MS Berat maksimum
HI अधिकतम वजन
TH น้ำหนักสูงสุด
SQ Peshat maksimale
BS Maksimalne težine
ME Maksimalne težine
MK Максимални тежини
HY Առավելագույն քաշեր
VI Cáp mức cân nặng tối đa

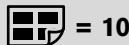

EN Product registration
DE Produktregistrierung
ES Registro del producto
FR Enregistrement du produit
PT Registo do produto
IT Registrazione del prodotto
NL Productregistratie
PL Rejestracja produktu
CS Registrace výrobku
SK Registrácia výrobku
SL Registracija izdelka
HR Registracija proizvoda
HU Termékregisztráció
SE Produktregistrering
NO Produktregistrering
FI Tuotteen rekisteröinti
DA Produktregistrering
ET Toote registreerimine
LV Produkta registrācija
LT Gaminio registracija
RU Регистрация продукта
UK Реєстрація продукту
TR Ürün kaydı

EL Καταχώριση προϊόντος
RO Înregistrarea produsului
IS Skráning tækis
MT Registrazzjoni tal-prodott
AR تسجيل المنتج
FA ثبت محصول
YUE 產品註冊
CMN 产品注册
JA 製品の登録
KO 제품 등록
BG Регистрация на продукта
SR Registracija proizvoda
MS Pendaftaran produk
HI उत्पाद पंजीकरण
TH การลงทะเบียนผลิตภัณฑ์
SQ Regjistrimi i produktit
BS Registracija proizvoda
ME Registracija proizvoda
MK Регистрација на производ
HY Արժույթի գրանցում
VI Đăng ký sản phẩm

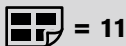

= 11

EN	Set up	EL	Στήσιμο
DE	Aufbau	RO	Setare
ES	Instalación	IS	Uppsetning
FR	Montage	MT	Konfigurazzjoni
PT	Preparação	AR	تنصيب
IT	Configurazione	FA	برپا کردن
NL	Opbouw	YUE	設置
PL	Montaż	CMN	设置
CS	Nastavení	JA	セットアップ
SK	Nastavenie	KO	설정
SL	Nastavitev	BG	Настройка
HR	Postavljanje	SR	Postavljanje
HU	Felszerelés	MS	Persediaan
SE	Inställning	HI	सेट अप
NO	Oppsett	TH	การติดตั้ง
FI	Asennus	SQ	Konfigurimi
DA	Opsætning	BS	Postavljanje
ET	Seadistamine	ME	Postavljanje
LV	Uzstādīšana	MK	Поставување
LT	Nuostatos	HY	Հարգաւորում
RU	Установка	VI	Cài đặt
UK	Встановлення		
TR	Kurulum		

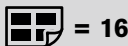

= 16

EN	Usage on the stroller frame	EL	Χρήση στο πλαίσιο του καροτσιού
DE	Verwendung auf dem Kinderwagengestell	RO	Utilizare pe cadrul căruciorului
ES	Uso en el bastidor del cochecito	IS	Notkun á ramma vagnsins
FR	Utilisation sur le cadre du landau	MT	Użu fuq il-qafas tal-pramm
PT	Utilização na estrutura do carrinho	AR	الاستخدام على إطار عربة الأطفال
IT	Uso del telaio del passeggino	FA	استفاده بر روی شاسی کالسکه
NL	Gebruik op het frame van de wandelwagen	YUE	在嬰兒車車架上使用
PL	Stosowanie na ramie wózka	CMN	在婴儿车车架上使用
CS	Použití na rámu kočárku	JA	ベビーカーフレームの使用
SK	Použitie na ráme kočika	KO	유모차 프레임 사용
SL	Uporaba na okvirju vozička	BG	Употреба върху рамката на детската количка
HR	Upotreba na okviru kolica	SR	Upotreba na okviru kolica
HU	A babakocsi keretén való használat	MS	Penggunaan pada rangka kerusi tolak
SE	Användning på sittvagnsramen	HI	स्ट्रोलर फ्रेम पर उपयोग
NO	Bruk på barnevognrammen	TH	การใช้งานบนเฟรมรถเข็นเด็ก
FI	Käyttö rattaiden rungolla		

DA Anvendelse på klapvognsstellet

SQ Përdorimi në skeletin e karrocës

ET Kasutamine jalutuskäru raamil

BS Upotreba na okviru kolica

LV Izmantošana uz bērnu ratiņu rāmja

ME Upotreba na okviru kolica

LT Vežimėlio rėmo naudojimas

MK Користење на рамката на количка

RU Использование на раме детской коляски

HY Մանկասայլալի կմախքի գործածութեանը

UK Використання рами візка

VI Sử dụng trên khung xe đẩy

TR Çocuk arabası kasasında kullanım



= 17

EN Folding

DE Faltung

ES Plegado

FR Pliant

PT Fecho

IT Ripiegamento

NL Vouwen

PL Składanie

CS Skládání

SK Zloženie

SL Zlaganje

HR Preklapanje

HU Összecsukás

SE Ihopfällning

NO Sammenlegging

FI Kokoon taittaminen

DA Sammenklapning

ET Kokkuvoltimine

LV Salocīšana

LT Lankstymas

RU Складывание

UK Складання

TR Katlama

EL Αναδίπλωση

RO Pliere

IS Brjóta saman

MT Tiwi

AR

FA

YUE 折疊

CMN 折疊

JA 折りたたみ

KO 접기

BG Сгъване

SR Preklapanje

MS Lipat

HI फोड़ना

TH ภางพับ

SQ Palosja

BS Preklapanje

ME Preklapanje

MK Склопување

HY Շախելը

VI Gập lại

قابله للطي
تا كردن

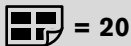

EN	Sun canopy	EL	Κουκούλα για τον ήλιο
DE	Sonnenverdeck	RO	Copertină
ES	Capota para el sol	IS	Sólartjald
FR	Pare-soleil	MT	Kopertura mix-xemx
PT	Capota solar	AR	مظلة الشمس
IT	Parasole	FA	سایبان
NL	Zonnekap	YUE	遮陽蓬
PL	Oslona przeciwsłoneczna	CMN	遮阳蓬
CS	Stříška proti slunci	JA	日よけカバー
SK	Strieška proti slnku	KO	선 캐노피
SL	Senčnik za zaščito pred soncem	BG	Тента
HR	Tenda za sunce	SR	Tenda za sunce
HU	Kupola	MS	Kanopi matahari
SE	Solsufflett	HI	धूप छतरी
NO	Solskjerm	TH	หลังคาบังแดด
FI	Aurinkokatos	SQ	Strea për diellin
DA	Solkaleche	BS	Tenda za sunce
ET	Päikesevari	ME	Tenda za sunce
LV	Saules aizsegs	MK	Стреа за сонце
LT	Stogelis nuo saulės	HY	Սրահապաշտպան ծածկ
RU	Солнцезащитный козырек	VI	Mái che nắng
UK	Тент від сонця		
TR	Güneş başlığı		

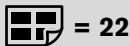

EN	Removing the fabric	EL	Αφαίρεση του υφάσματος
DE	Entfernen des Bezuges	RO	Îndepărtarea țesăturii
ES	Quitar la tela	IS	Fjarlægja efni
FR	Retrait du tissu	MT	Tnehhija tad-drapp
PT	Remover o tecido	AR	فك القماش
IT	Rimozione del tessuto	FA	برداشتن پارچه
NL	De stof verwijderen	YUE	拆除罩布
PL	Zdejmowanie pokrycia	CMN	拆除罩布
CS	Odstranění látky	JA	カバーの取り外し
SK	Odstránenie látky	KO	페브릭 제거
SL	Odstranjevanje blaga	BG	Демонтиране на плата
HR	Uklanjanje tkanine	SR	Uklanjanje tkanine
HU	Huzat eltávolítása	MS	Menanggalkan fabrik
SE	Ta bort tyget	HI	कपड़ा हटाना
NO	Fjerne stoffet	TH	การถอดผ้า
FI	Kankaan poisto	SQ	Heqja e copës
DA	Fjernelse af stoffet	BS	Uklanjanje tkanine
ET	Kanga eemaldamine	ME	Uklanjanje tkanine
LV	Pārklājuma atvienošana	MK	Отстранување на навлаката
LT	Audinio nuėmimas	HY	Գործվածքը հանելը
RU	Снятие ткани	VI	Tháo phần vải bọc
UK	Зняття матерії		
TR	Kilifi çikarma		

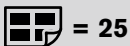

EN	Rain cover	EL	Καλύπτρα βροχής
DE	Regenverdeck	RO	Prelată de ploaie
ES	Funda para la lluvia	IS	Regn yfirbreiðsla
FR	Housse de pluie	MT	Għata mix-xita
PT	Capa de chuva	AR	غطاء المطر
IT	Parapioggia	FA	روکش باران
NL	Regenhoes	YUE	防雨罩
PL	Ostona od deszczu	CMN	防雨罩
CS	Pláštěnka	JA	雨ふけ
SK	Kryt proti dažďu	KO	레인커버
SL	Dežna prevleka	BG	Дъждобран
HR	Pokrivač za kišu	SR	Pokrivač za kišu
HU	Esővédő	MS	Pelindung hujan
SE	Regnskydd	HI	रेन कवर
NO	Kalesje	TH	ผ้าคลุมกันฝน
FI	Sadesuoja	SQ	Mbulesë për shiun
DA	Regnslag	BS	Pokrivač za kišu
ET	Vihmakate	ME	Pokrivač za kišu
LV	Pretlietus pārvalks	MK	Прекривна за дожд
LT	Uždangalas nuo lietaus	HY	Անձրևապաշտպան ծածկ
RU	Дождевик	VI	Tấm che mưa
UK	Дощовик		
TR	Yağmurluk		

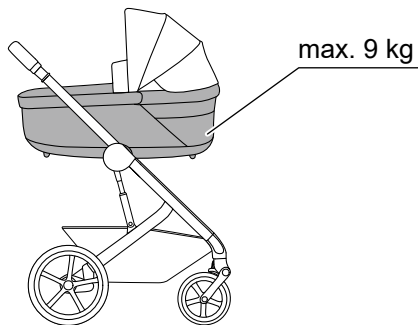

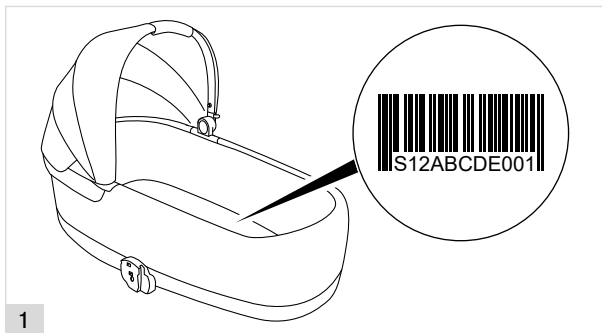

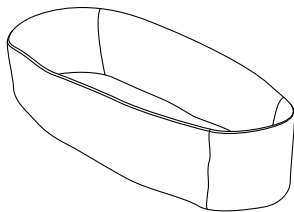
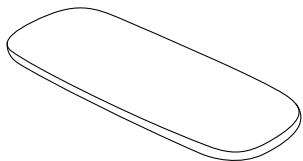
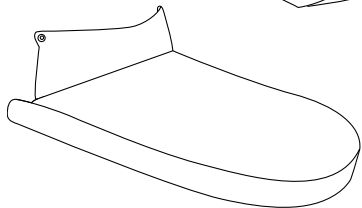
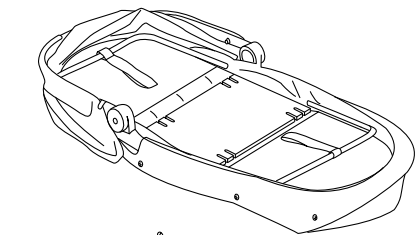

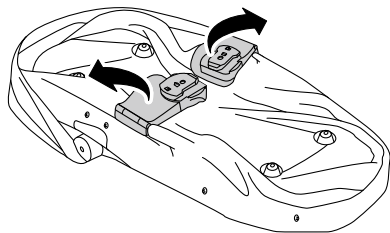

2

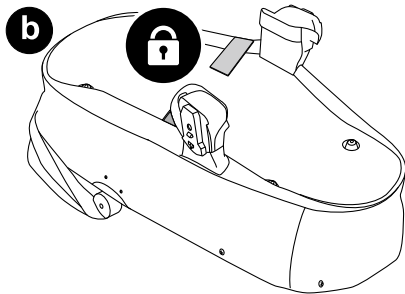
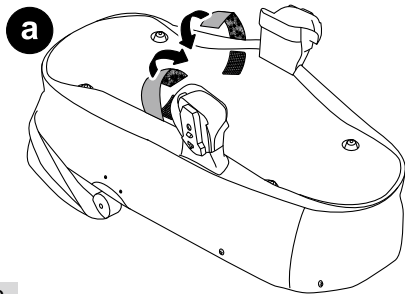

3



4

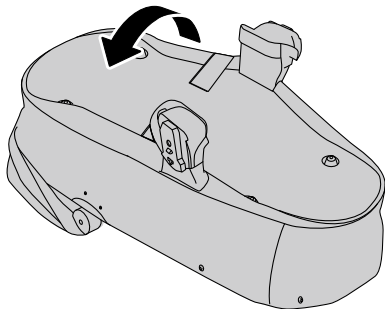

5

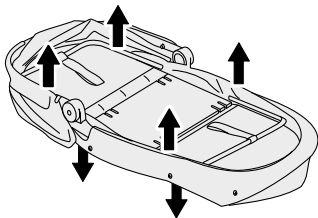

6

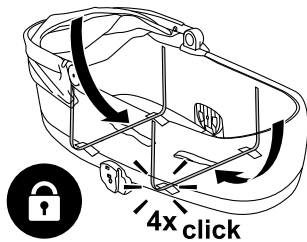



a

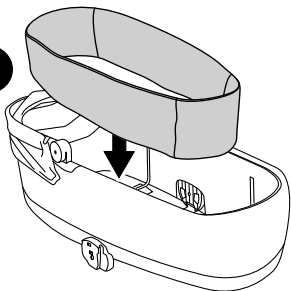

b

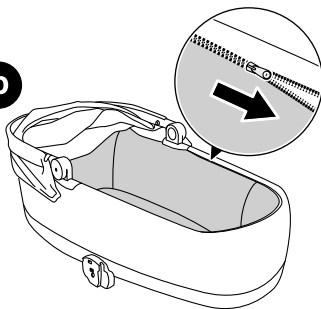

c

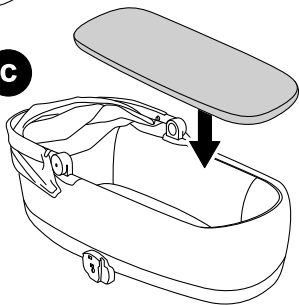

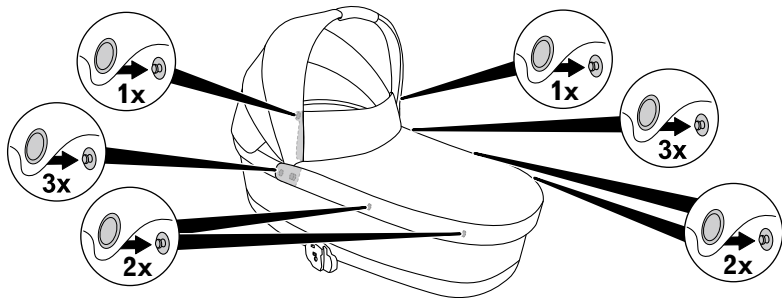

8

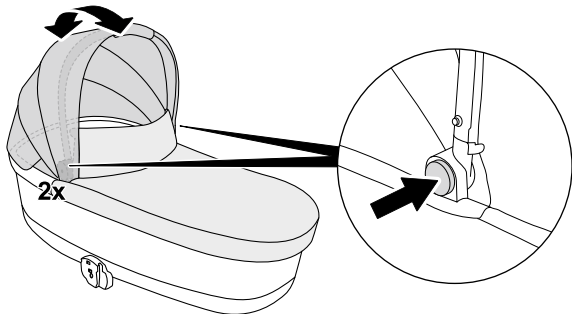

9



1

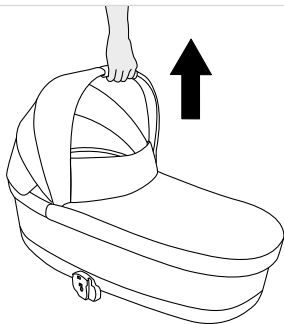

2

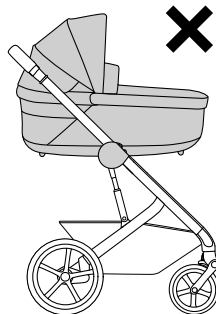
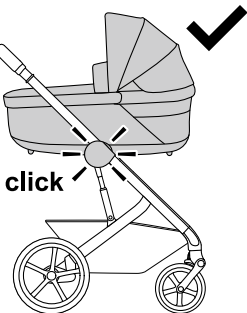

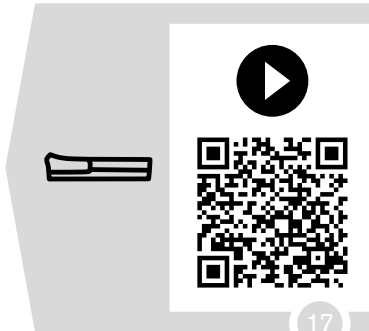
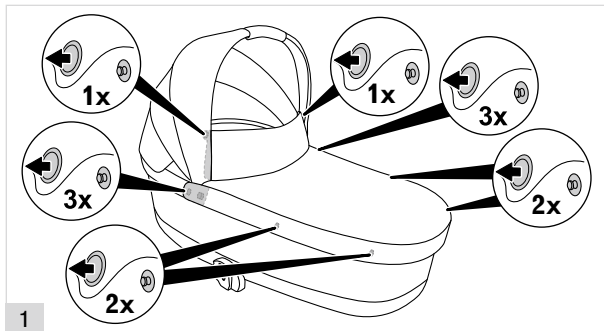
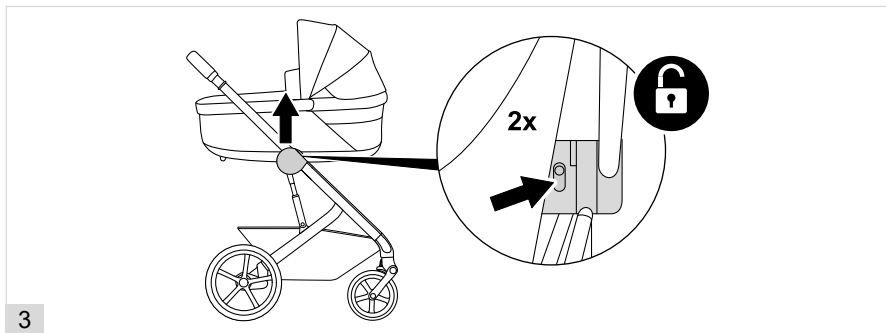

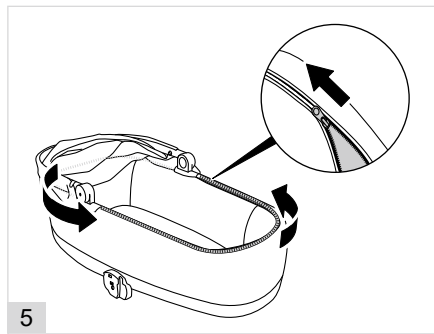
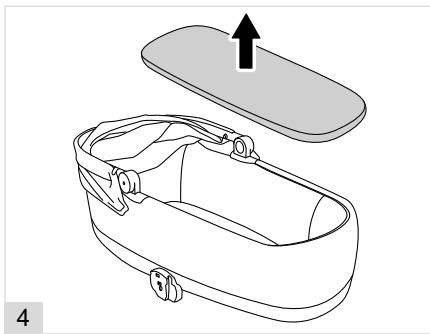
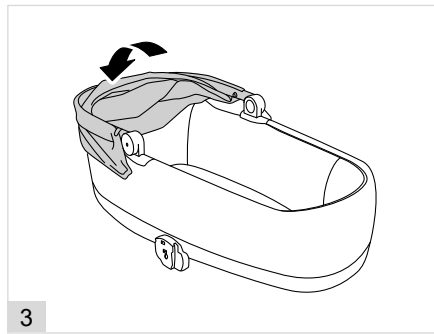
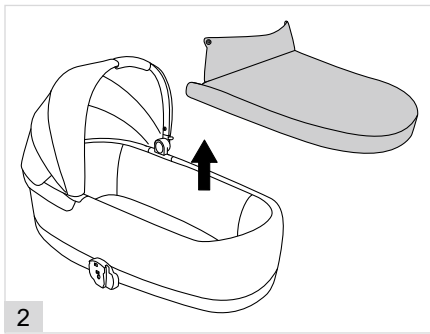

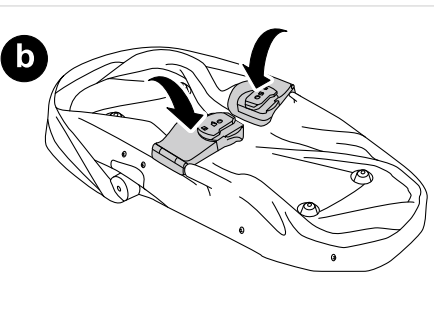
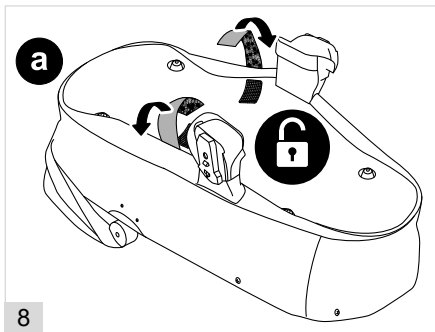
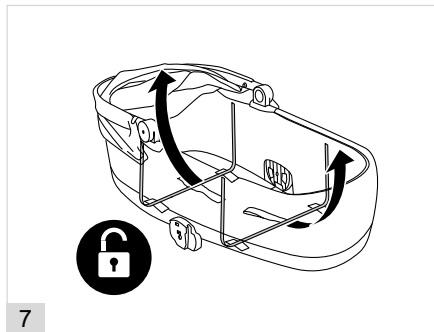
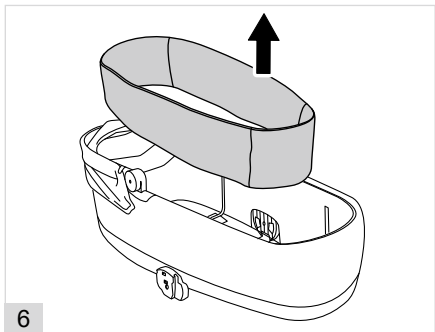



a

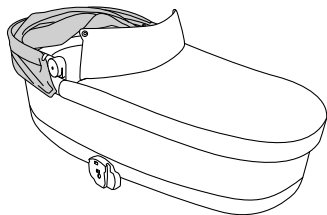

1

b

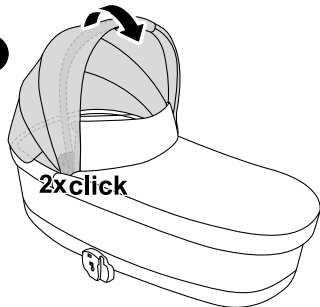

c

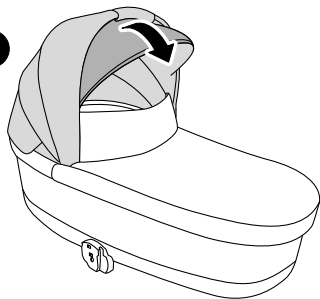

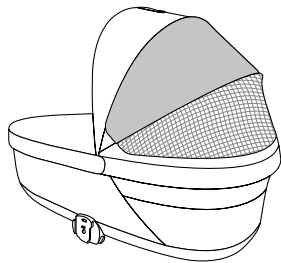
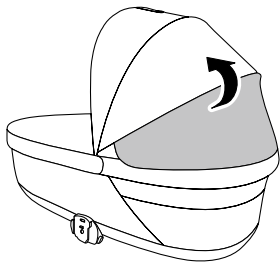

3

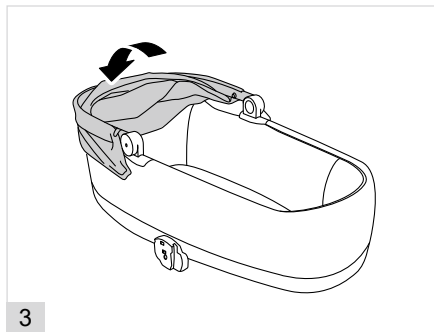
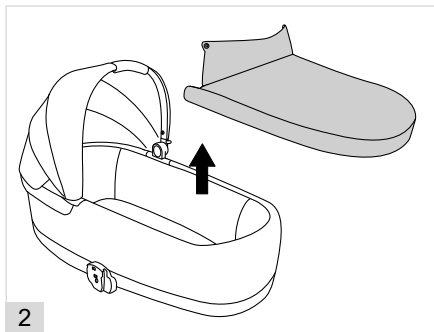
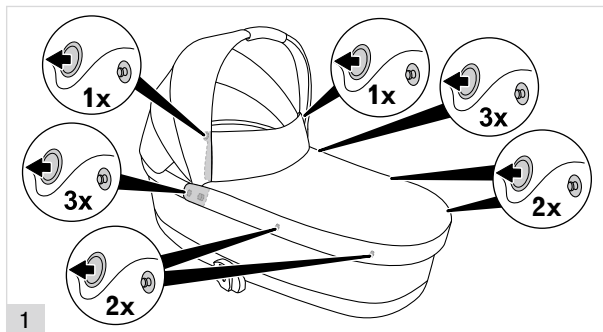

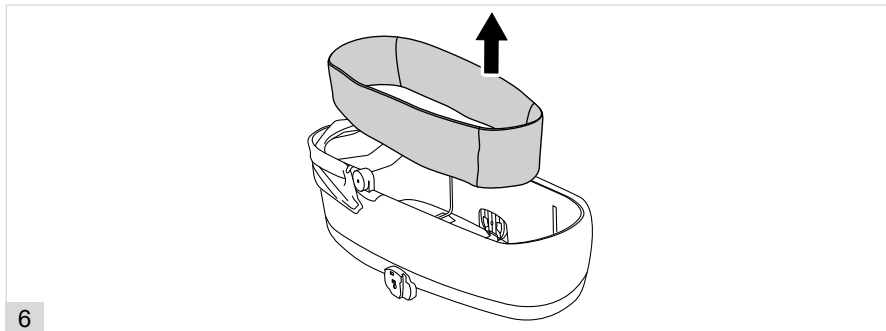
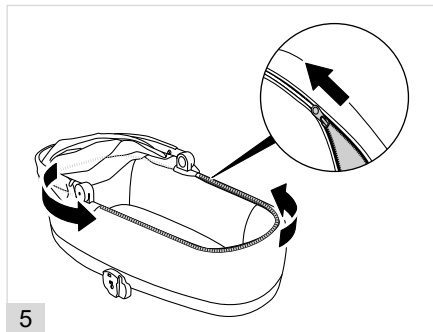
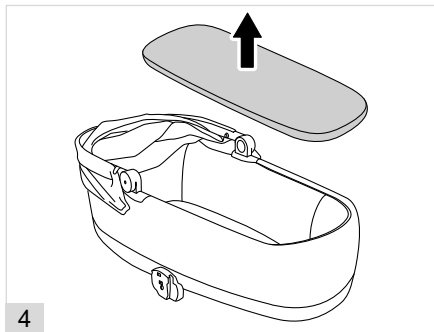

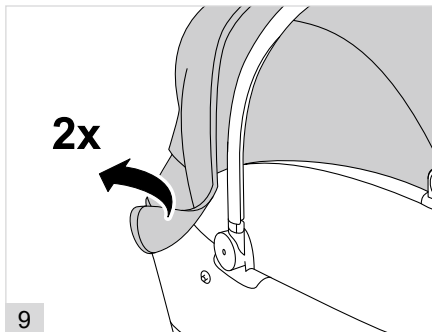
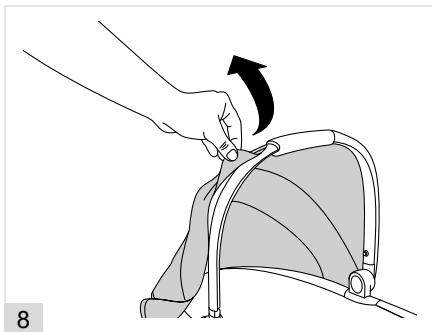
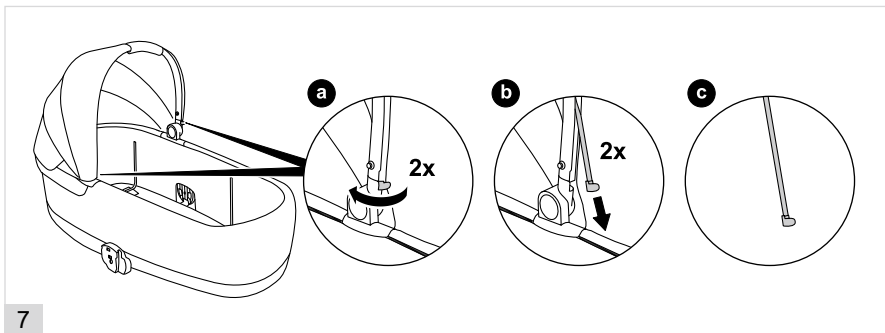

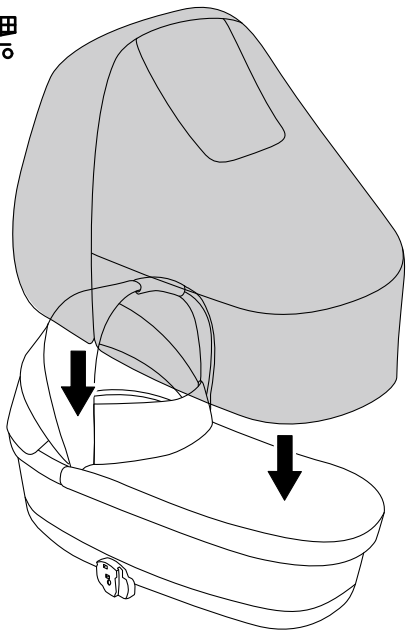

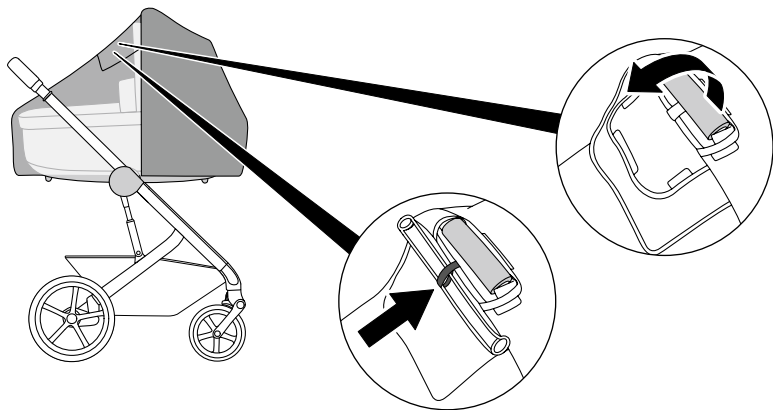



CYBEX GmbH

Riedingerstr. 18 | 95448 Bayreuth | Germany
+49 (0) 921-78 511-0 | info@cybex-online.com

www.cybex-online.com

